

Data Sheet



Article number: 025798400108

Description: Norma Connect pipe coupling
GRIP E W2 Ø=108,0 NBR, 16 bar

Measures

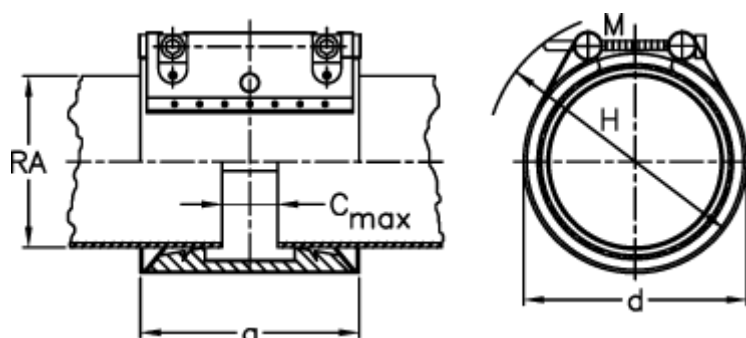

a	= 98
C max with insertion band	= 25
d	= 130
H	= 150
M (screw)	= M10
Nominal pressure (bar)	= 16
RA	= 108
RA min-RA max	= 106,9-109,1

Weight a piece = 1.7